

Festpunkt Type TFP

NW 15 - 200

h = 100

Jede andere Bauhöhe sowie ein Neigen der Rohrschellenachse ist möglich.

Tatsächliche Abmessungen der Rohrbefestigungen hängen von den einzelnen Profiltoleranzen ab.
Berechnungsgrundlagen der Belastungswerte siehe Seite 2.0 und 2.1. Die angegebenen Belastungswerte sind für Material S235JR bei Raumtemperatur angegeben.

Technische Änderungen vorbehalten.

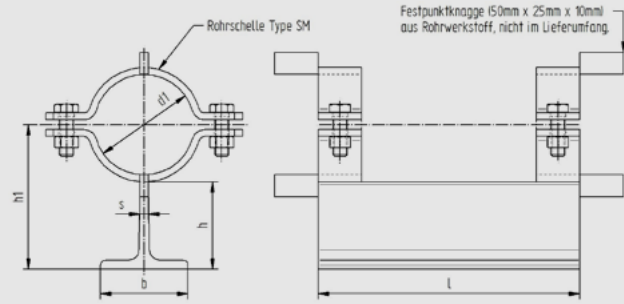

d1	Nennweite	Profil bxhxs	h	h1	l	Gewicht kg/Stk.	Fx (kN)	Fy (kN)	Fz (kN)
22	15	100x100x11	100	116	300	5,52	2,1	3,4	4,8
27	20	100x100x11	100	118	300	5,56	1,9	2,8	4,8
34	25	100x100x11	100	122	300	5,60	1,6	2,4	4,8
43	32	100x100x11	100	126	300	5,64	1,4	1,8	4,8
49	40	100x100x11	100	129	300	5,68	1,3	1,6	4,8
53	50	100x100x11	100	132	300	6,30	2,5	3,0	8,0
61	50	100x100x11	100	136	300	6,38	2,2	2,6	8,0
68	65	100x100x11	100	140	300	6,44	2,1	2,4	8,0
77	65	100x100x11	100	144	300	6,50	1,9	2,0	8,0
83	80	100x100x11	100	147	300	6,64	1,8	2,0	8,0
89	80	100x100x11	100	150	300	6,69	1,7	1,8	8,0
104	100	100x100x11	100	160	300	8,63	2,7	3,2	12,0
108	100	100x100x11	100	162	300	8,71	2,6	3,2	12,0
115	100	100x100x11	100	165	300	8,82	2,4	3,0	12,0
129	125	100x100x11	100	172	300	9,07	2,2	2,6	12,0
133	125	100x100x11	100	174	300	9,13	2,2	2,6	12,0
140	125	100x100x11	100	178	300	9,32	2,1	2,4	12,0
154	150	100x100x11	100	185	300	9,61	1,9	2,2	12,0
159	150	100x100x11	100	187	300	9,67	1,9	2,2	12,0
169	150	100x100x11	100	192	300	9,88	1,8	2,0	12,0
191	175	100x100x11	100	203	300	10,30	1,6	1,8	12,0
204	200	100x100x11	100	210	300	10,58	1,5	1,8	12,0
220	200	100x100x11	100	218	300	10,89	1,4	1,6	12,0

